

1679

fapim[®]

Life in evolution

ULCR - Rev.01

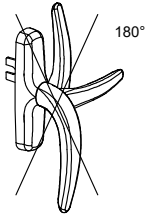
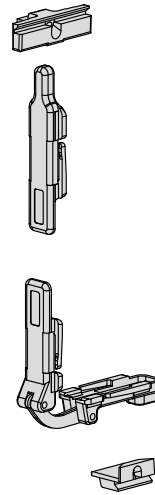
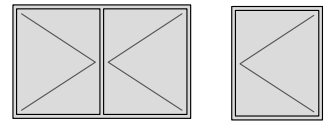

180°

1

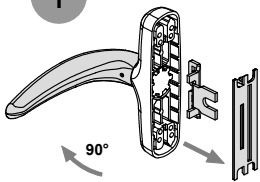

90°

2

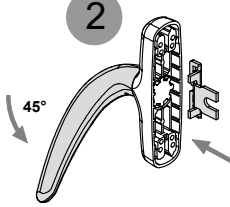

45°

3

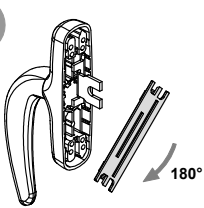

180°

4

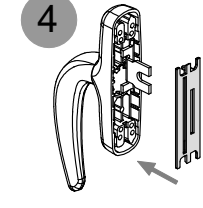

90°

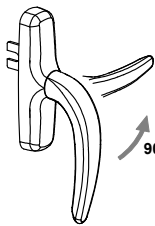

2

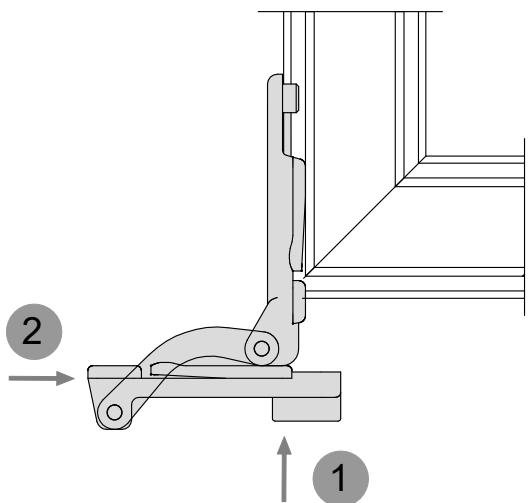

1

